



SPIRIT FITNESS

A Heritage of Quality | The Spirit of Innovation

Инструкция по сборке. Бицепс / трицепс-машина



Руководство пользователя



A Heritage of Quality | The Spirit of Innovation
SPIRIT
FITNESS



A Heritage of Quality | The Spirit of Innovation
SPIRIT
FITNESS



A Heritage of Quality | The Spirit of Innovation
SPIRIT
FITNESS

1

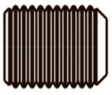
1  X2

M8X10 

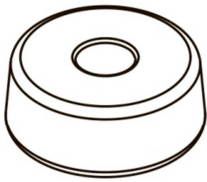
2  X2

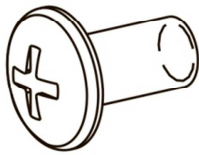

$\Phi 62 \times \Phi 26 \times 25$

3  X3

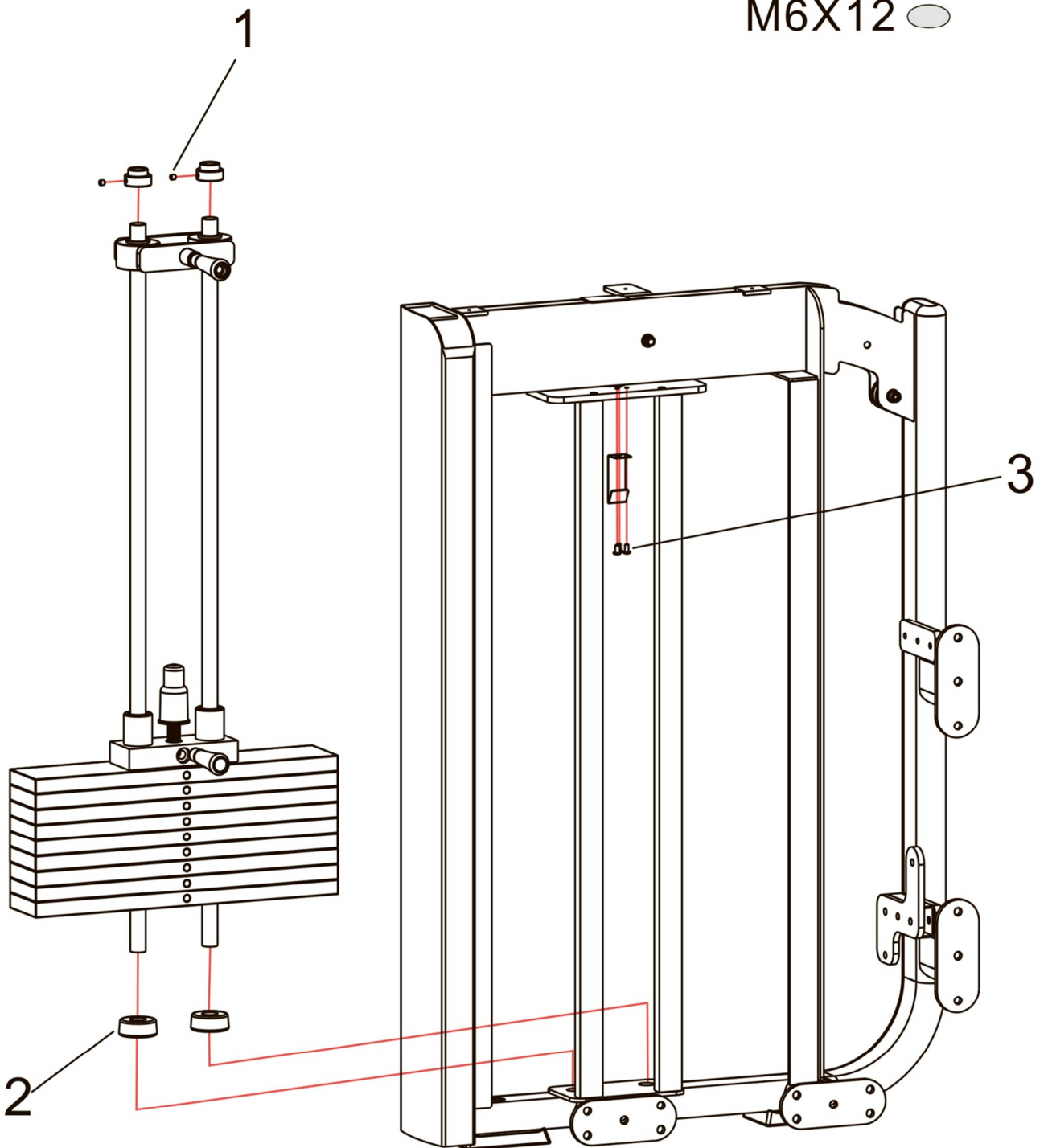
M6X12 

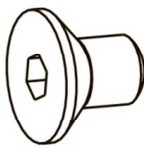

2

4  X2
M10X20 

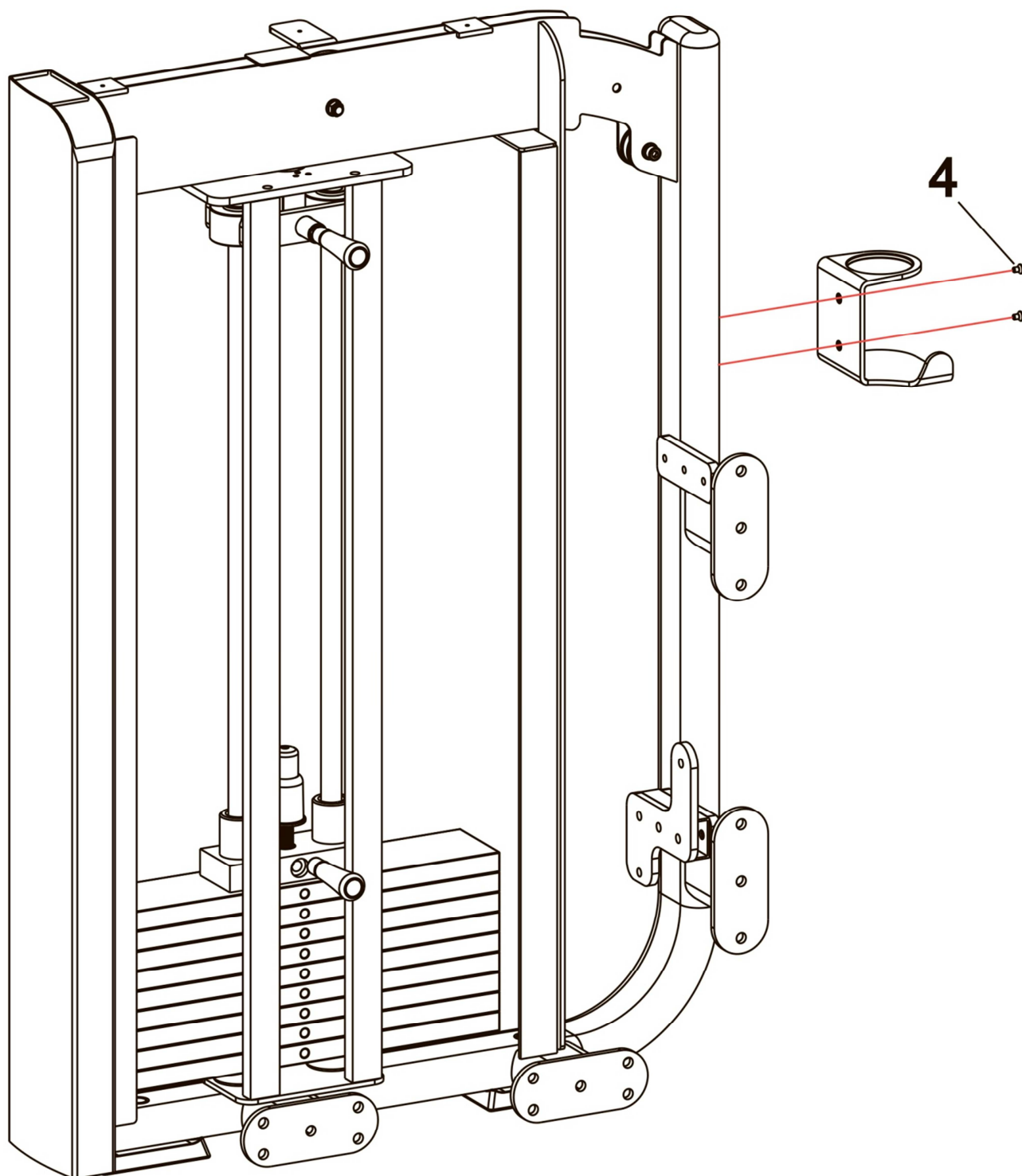

3

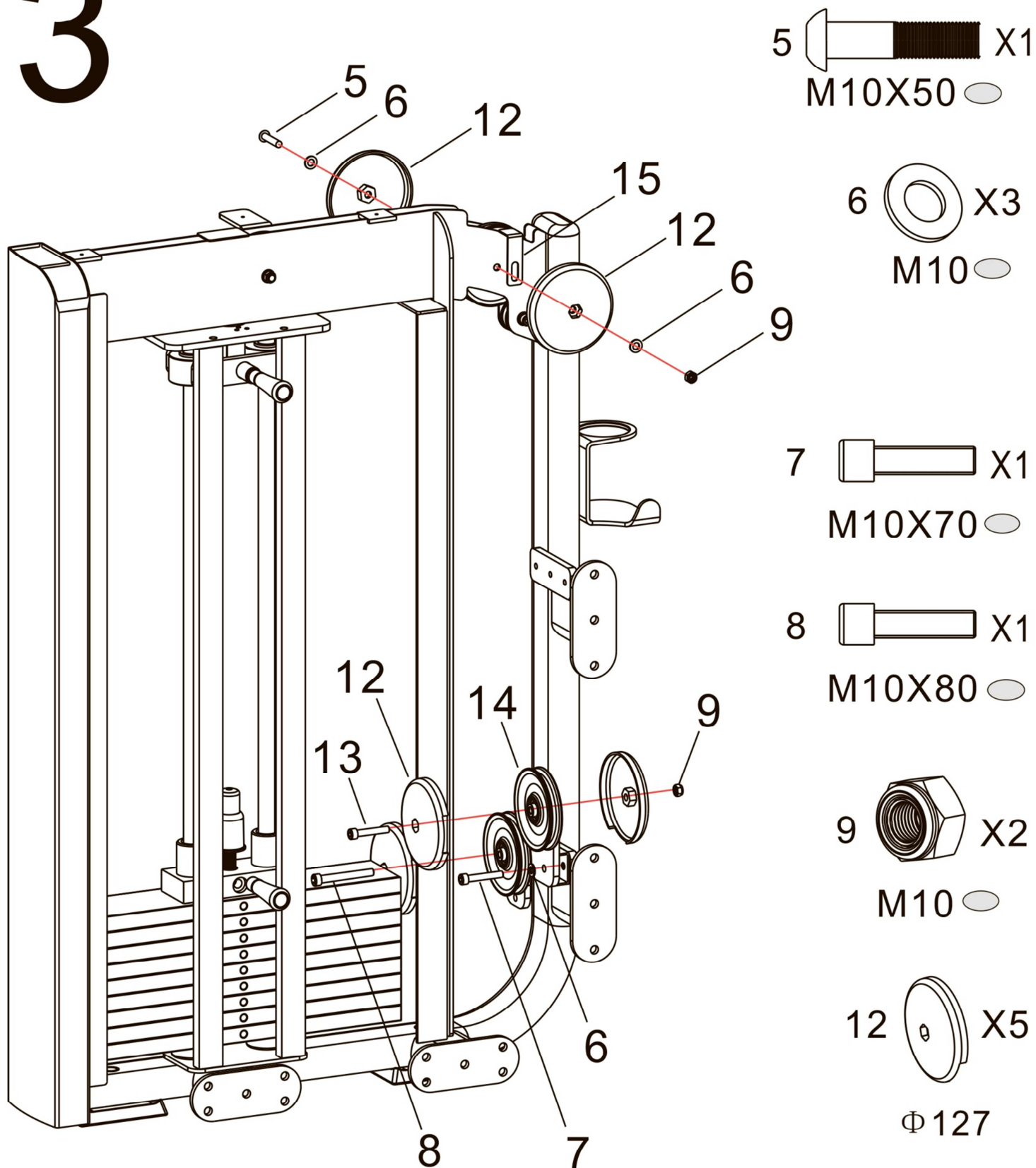

13 X1

M10X50

14 X3

$\Phi 127$

15 X 1

(35+80)*25*2



4

10  X2
M10 

16  X2
 $\Phi 49 * \Phi 61 * 350$

17  X2
 $\Phi 50 * 2.5$

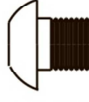

18  X2
M10 

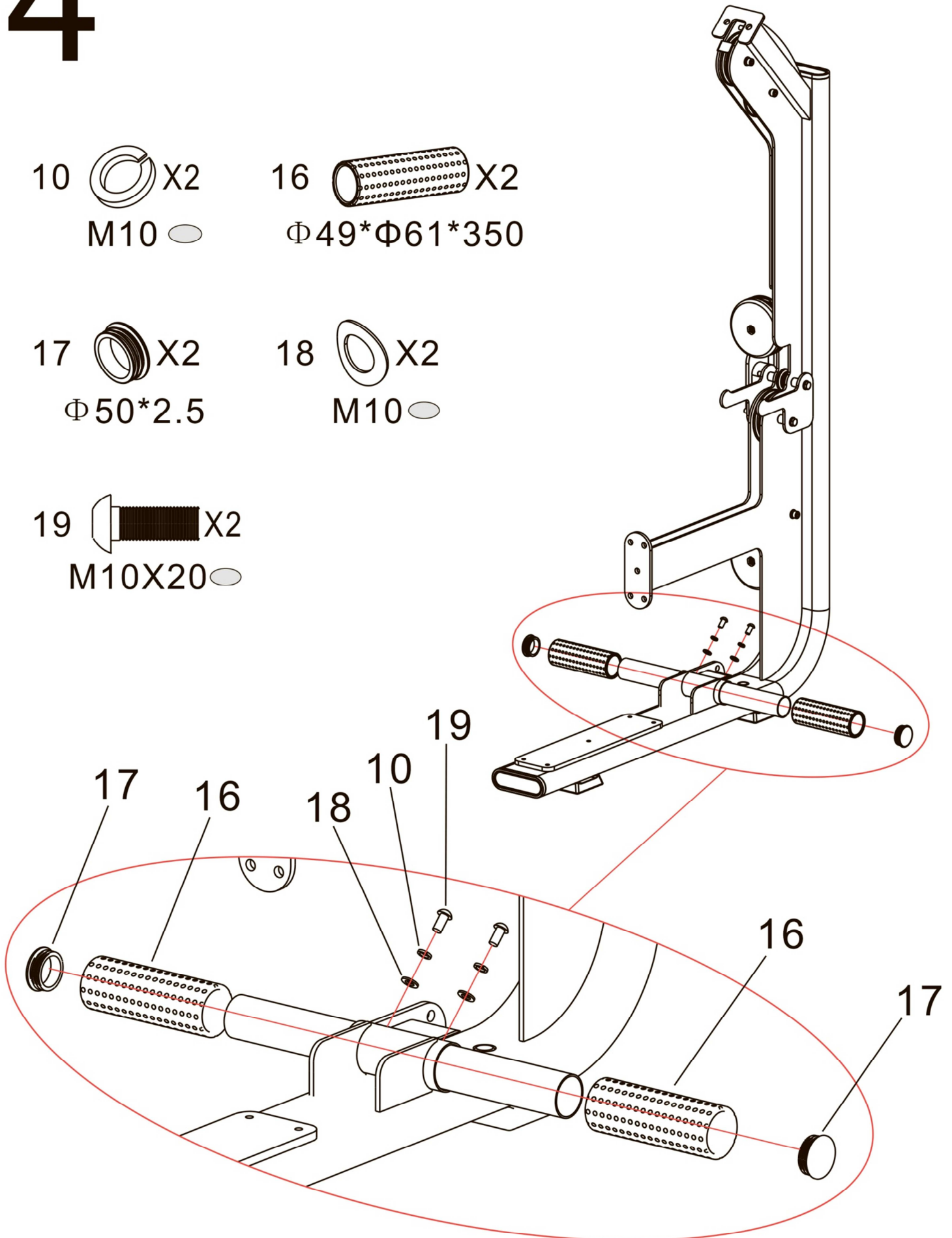

19  X2
M10X20 



5

6  X9
M10 

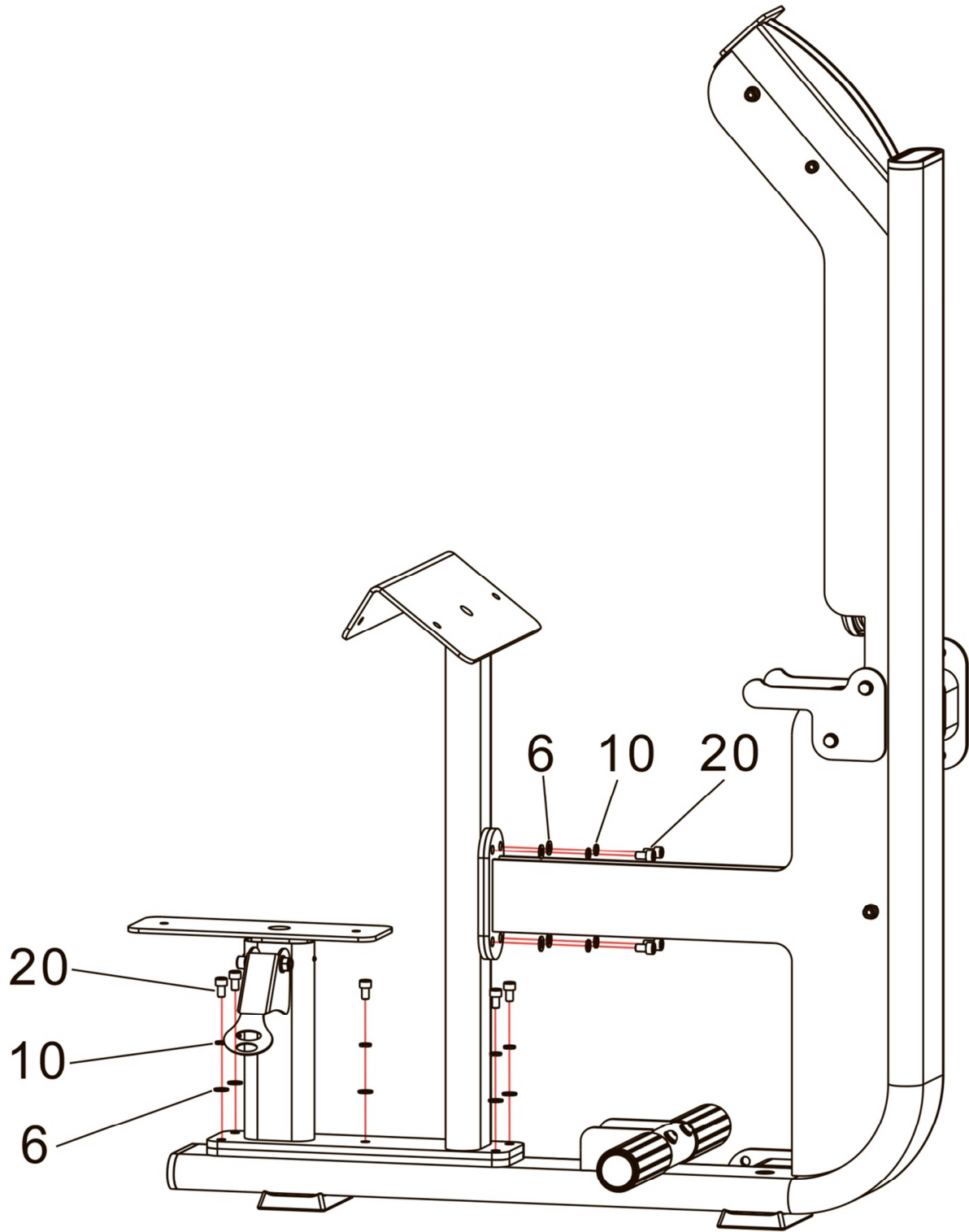

10  X9
M10 

20  X9
M10X35 



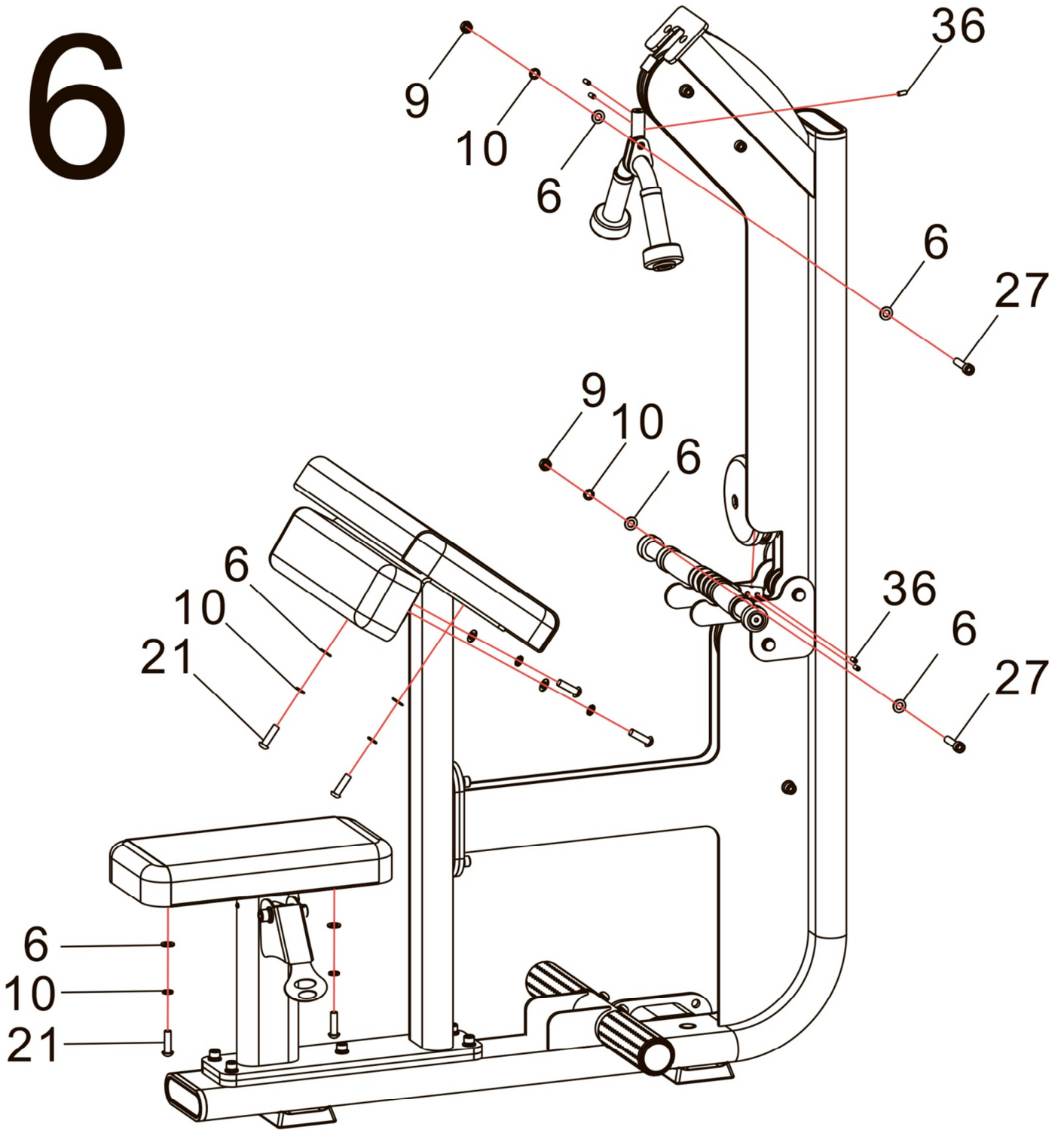

6





6  X10
M10 

9  X2
M10 

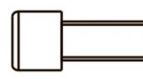

10  X8
M10 



21  X6
M10X35 

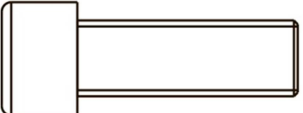

27  X2
M10X40 



36  X6
M8X8 

7

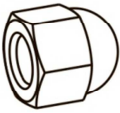
22  X18
M12X35 

23  X36
M12 

24  X18
M12 

35  X18
M12 

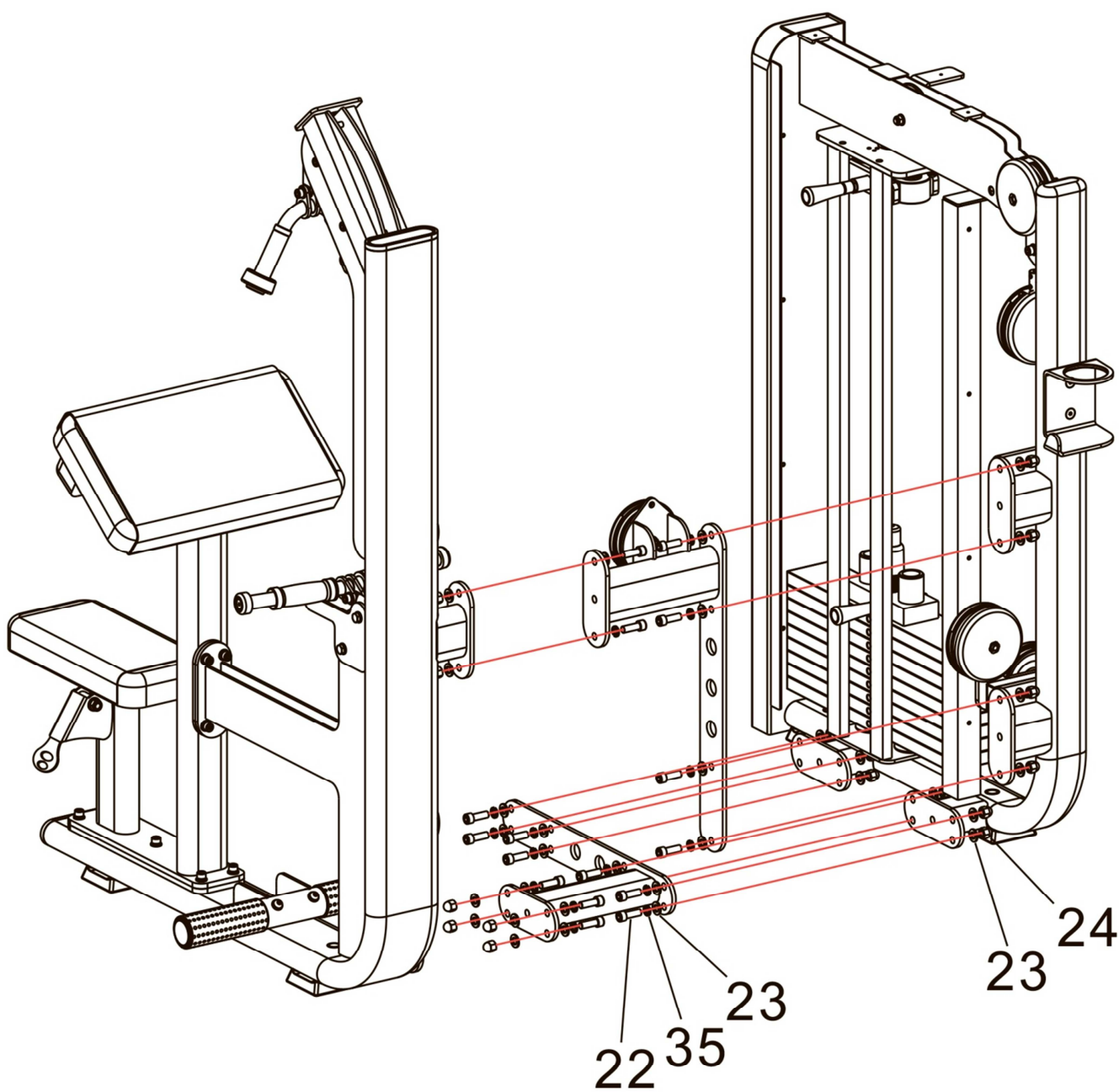

8

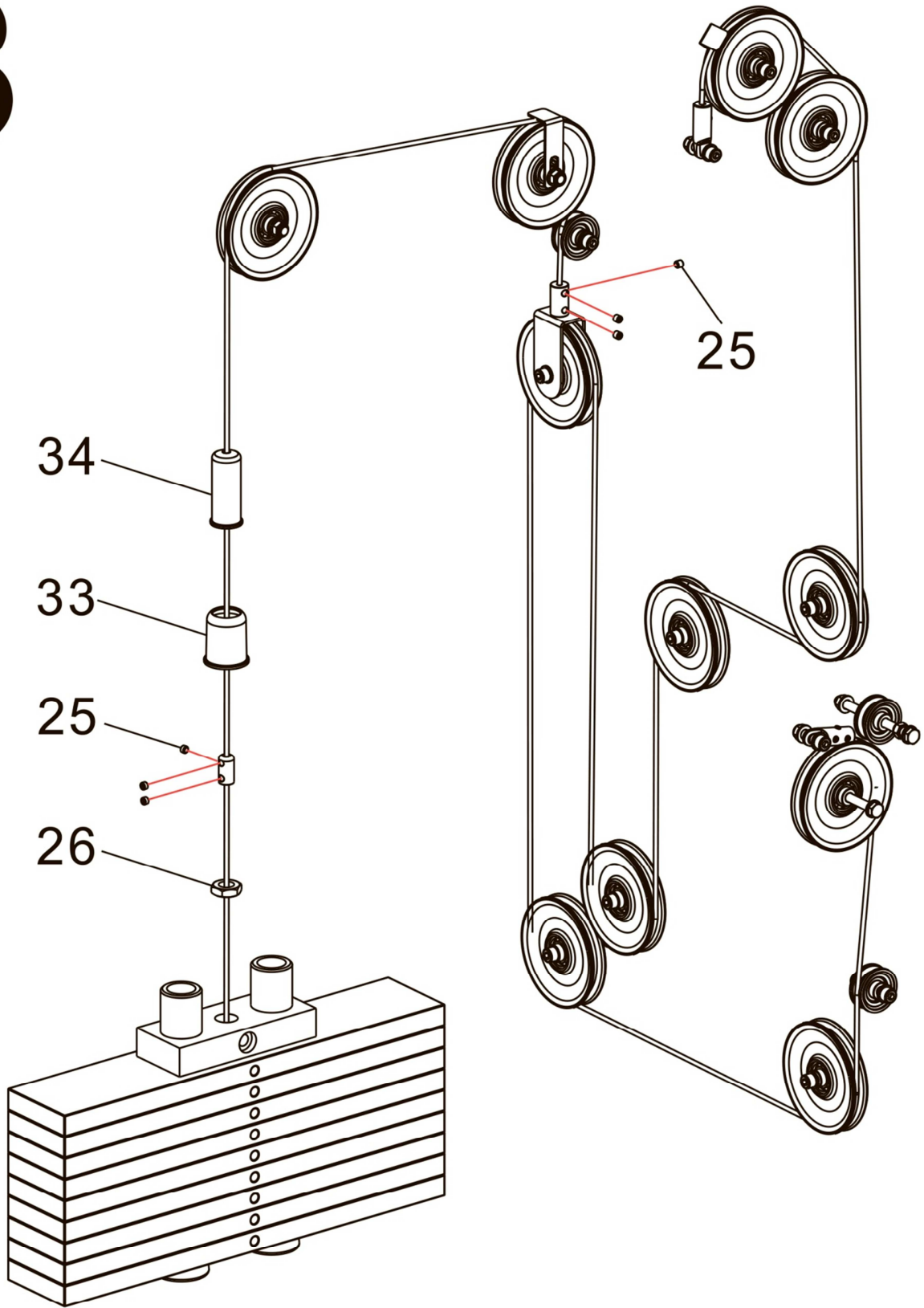



25  X6
M8X6 ●

26  X1
M20 ●



33  X1
Φ 50xΦ 32x58.4

34  X1
Φ 36xΦ 32xM20x85

9

28  X4
M8X15 



29  X4
M8 

30  X4
M8 

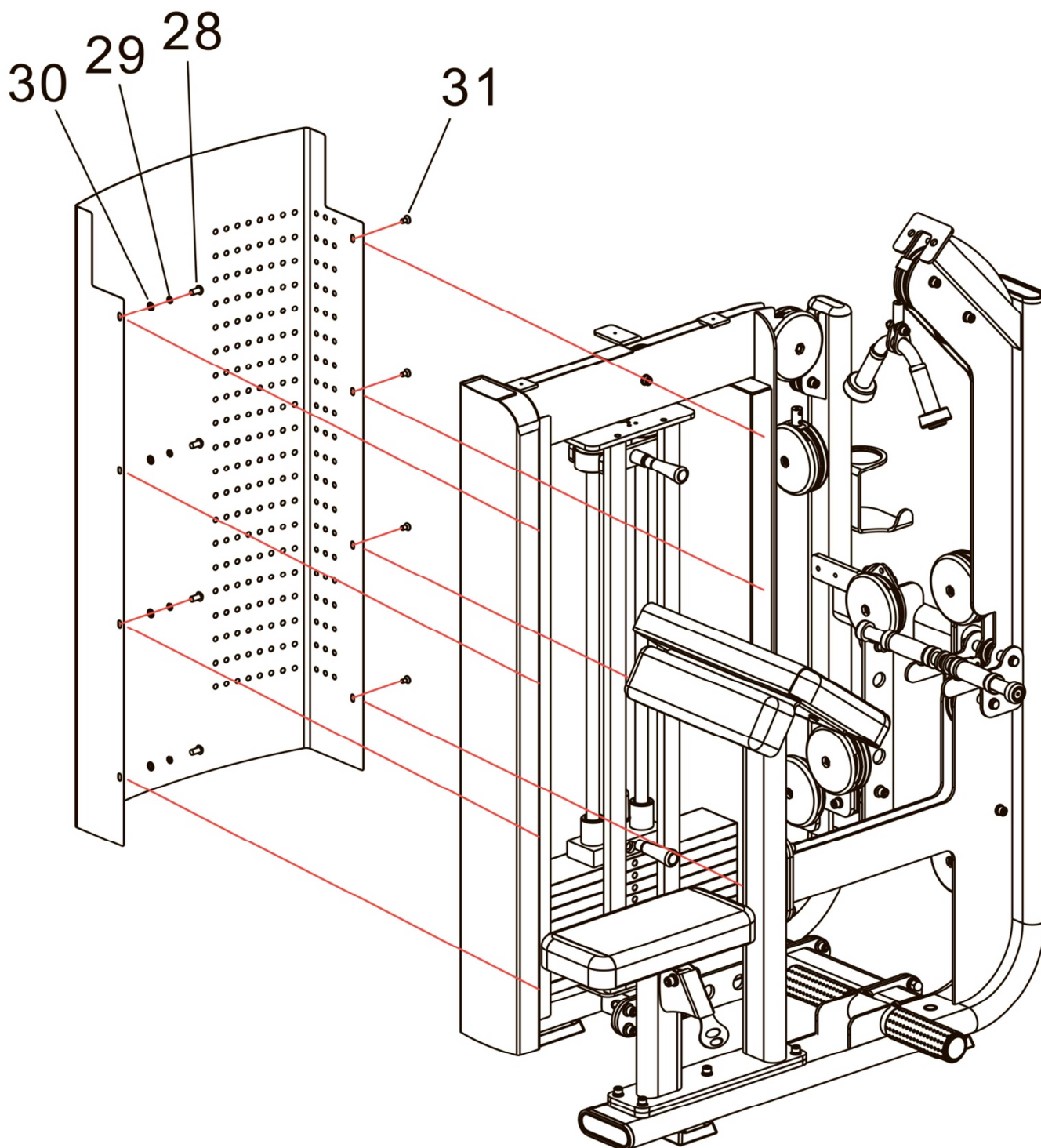



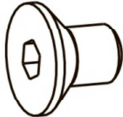



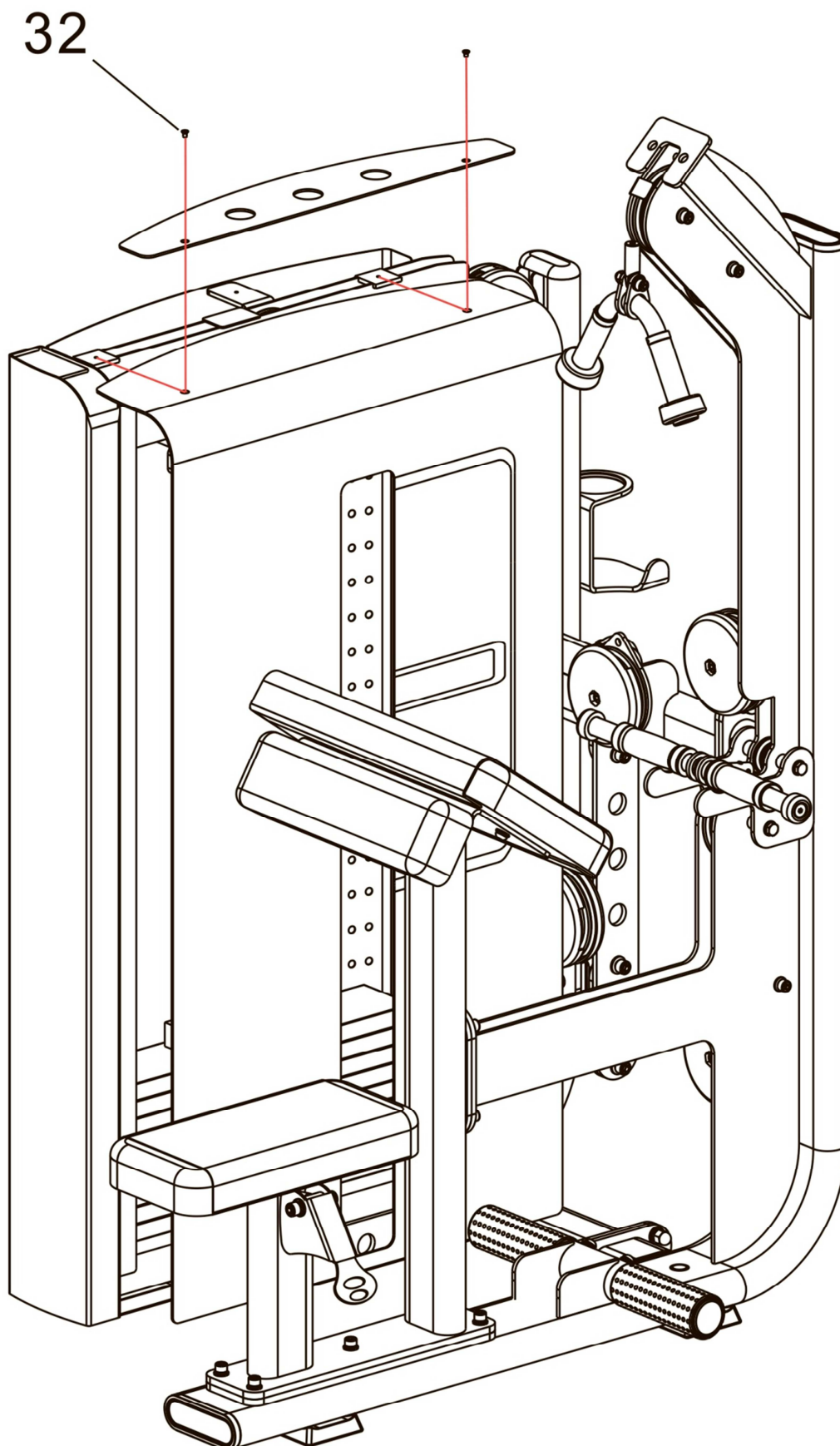



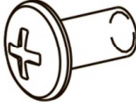











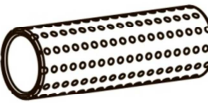

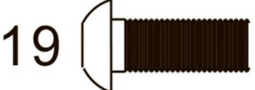
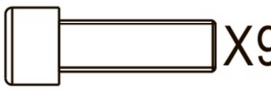



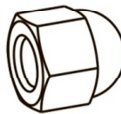

31  X4
M8X15 

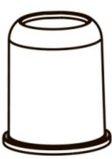

10

32  X2
M5X10 



- | | | | |
|--|---|---|---|
| 1  X2
M8X10 ● | 2  X2
$\Phi 62 \times \Phi 26 \times 25$ | 3  X3
M6X12 ○ | 4  X2
M10X20 ○ |
| 5  X1
M10X50 ○ | 6  X22
M10 ○ | 7  X1
M10X70 ○ | 8  X1
M10X80 ○ |
| 9  X4
M10 ○ | 10  X19
M10 ○ | 12  X5
$\Phi 127$ | 13  X1
M10X50 ○ |
| 14  X3
$\Phi 127$ | 15  X1
$(35+80) \times 25 \times 2$ | 16  X2
$\Phi 49 \times \Phi 61 \times 350$ | 17  X2
$\Phi 50 \times 2.5$ |
| 18  X2
M10 ○ | 19  X2
M10X20 ○ | 20  X9
M10X35 ○ | 21  X6
M10X35 ○ |
| 22  X18
M12X35 ○ | 23  X36
M12 ○ | 24  X18
M12 ○ | 25  X6
M8X6 ● |
| 26  X1
M20 ● | 27  X2
M10X40 ○ | 28  X4
M8X15 ○ | 29  X4
M8 ○ |
| 30  X4
M8 ○ | 31  X4
M8X15 ○ | 32  X2
M5X10 ○ | 33  X1
$\Phi 50 \times \Phi 32 \times 58.4$ |
| 34  X1
$\Phi 36 \times \Phi 32 \times M20 \times 85$ | 35  X18
M12 ○ | 36  X6
M8X8 ● | |